

# Reel for barrier tape

# EBINGER

Technisches Equipment



- Spring rewind mechanism
- Latching system
- Plastic casing shockproof and UV-resistant
- max. 16m nylon barrier tape in red/white
- Swivel mounting bracket
- Mountable in any position

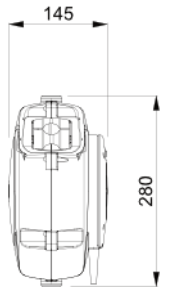
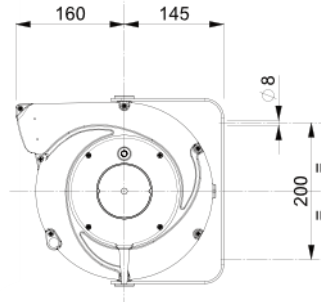
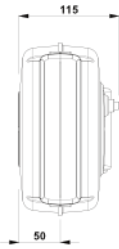
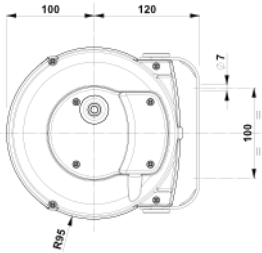

Model	Material casing	Length of tape	Item-No.
Mini	plastic	8m	1.990.210
X5000 B	plastic	16m	1.990.220



- Spring rewind mechanism
- Latching system
- Plastic casing shockproof and UV-resistant
- 28m nylon barrier tape in yellow/black
- Swivel mounting bracket
- Mountable in any position
- Rewinding break

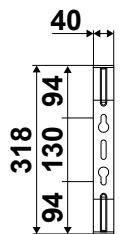
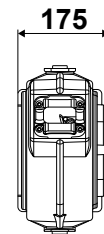
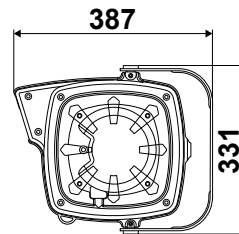

Model	Material casing	Length of tape	Item-No.
BA280 with rewinding break	plastic	28m	1.990.237

# EBINGER

Technisches Equipment

**Ebinger GmbH**  
Edesheimer Straße 51  
D-76835 Rhodt /  
Germany

Fon +49 (0)6323-937 465-0  
Fax +49 (0)6323-937 465-20

info@ebinger-gmbh.com  
www.ebinger-gmbh.com

